

# ACUMEN™

## Acumen Model Wmt-04

### Fireplace Remote Control Operating Instructions For The Homeowner

The Acumen Model WMT-04 Remote Control is designed for use with decorative gas fireplace and wall heaters using a Millivolt gas valve.

#### BEFORE YOU BEGIN:

**Warning** The pilot flame must be lit, with the gas control valve turned to "ON", for the remote to work correctly. Read all of the safety precautions in the owner's manual included with your fireplace before using this remote control. The thermostat is not intended for unattended use.

#### 1.0 INSTALLING FRESH BATTERIES:

**Note:** It is not necessary to re-set your private code when installing fresh batteries.

**The fireplace MUST be OFF before replacing transmitter batteries.**

#### 1.1 RECEIVER CHANGING BATTERIES: see Figure 1

- 1 The Remote Receiver uses 4 pieces AA-size batteries. Slide the slide switch at the Remote Receiver to the Off position.
- 2 Press the battery compartment slightly into the Remote Receiver and then release. The battery compartment will pop out of the Remote Receiver.
- 3 Slide open the battery door and replace batteries.
- 4 Replace the battery door and slide the battery compartment back into the Remote Receiver.

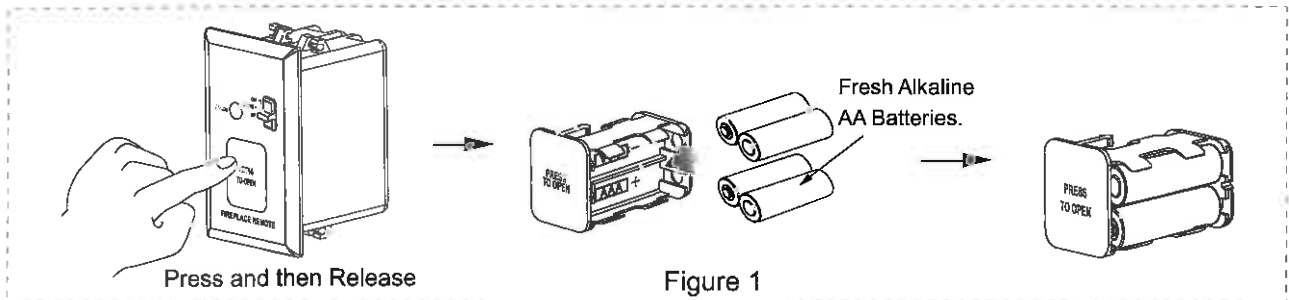

#### 1.2 WALL MOUNT CHANGING BATTERIES: see Figure 2

- 1 The Remote WALL MOUNT uses 3 AAA-size batteries. Replace these batteries at least every 6 months or when the Low battery indicator on the LCD is on.
- 2 Press the battery compartment slightly into the Remote WALL MOUNT and then release. The battery compartment will pop out of the Remote WALL MOUNT.
- 3 Slide open the battery door and replace batteries.
- 4 Replace the battery door and slide the battery compartment back into the Remote WALL MOUNT.
- 5 After you take out the batteries, wait for at least 1 minute before putting fresh batteries into the Remote WALL MOUNT and Receiver.
- 6 Use fresh alkaline batteries only.

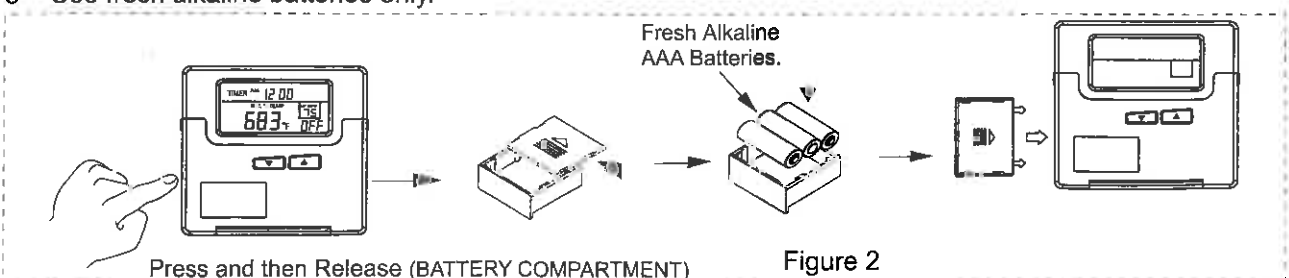

**WARNING: THE REMOTE WALL MOUNT WILL AUTOMATICALLY SWITCH OFF THE FIREPLACE WHEN THE BATTERIES IN THE REMOTE WALL MOUNT IS LOW.**

## 2.0 OPERATION INSTRUCTIONS:

### 2.1 Wall Mount Transmitter Operation

The WMT-04 Wall Mount Remote Control has 3 operating modes. They are: Manual, Auto and Timer. Use the Up and Down buttons to set the target temperature between 45°F and 90 °F, or 8 °C and 32 °C.

#### A. Settings : see Figure 3

- 1 Press and hold clock button for about 2 seconds.
- 2 The hour display will flash. Use the Up and Down buttons to set the hour.
- 3 Press the clock button again and the minute display will flash. Use the Up and Down buttons to set the minutes.
- 4 Press the clock button again and the oF or oC display will flash. Use the Up and Down button to select the Remote Transmitter to display temperature in oF or oC.
- 5 Press the clock button again to exit setting.

Figure 3

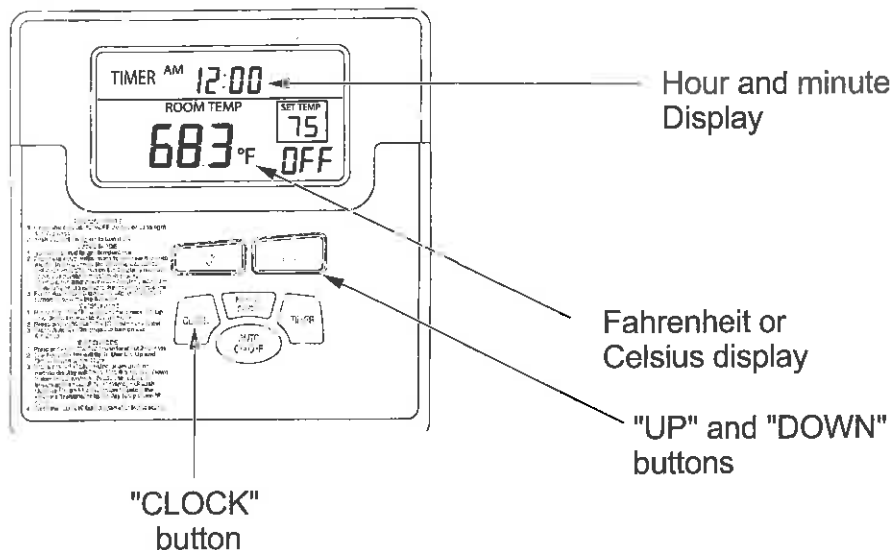

#### B. Manual Mode: see Figure 4

- 1 Press the Manual On/Off button once to light the fireplace. Push the button again to turn it off.
- 2 In Manual mode the Remote Transmitter will not turn the fireplace off even if the room temperature exceeds the target temperature.
- 3 The fireplace will automatic turn off after 6 hours.

Figure 4

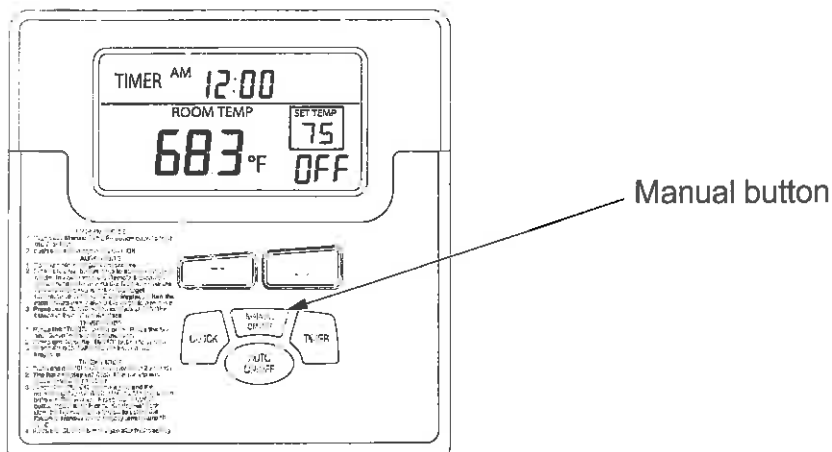

**C. Auto Mode: see Figure 5**

- 1 Set the desired target temperature.
- 2 Press the Auto On/Off button once to activate the Auto mode. In Auto Mode the Remote Transmitter will automatically turn on the fireplace when the room temperature is below the target temperature and turn off the fireplace when the room temperature is above the target temperature.
- 3 Press Auto On/Off button or Manual On/Off buttons to turn off the fireplace (if it is already on) and exit Auto Mode. **WARNING: IT TAKES SOME TIME FOR THE RECEIVER TO RESPOND TO THE TRANSMITTER. DO NOT PRESS THE MANUAL OR AUTO ON/OFF BUTTONS MORE THAN ONCE WITHIN 2 SECONDS FOR CORRECT OPERATION.**

Figure 5

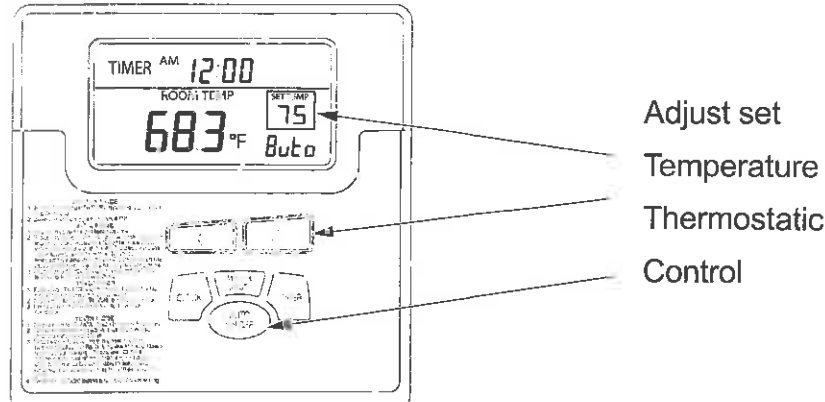

**D. Timer Mode: see Figure 6**

- 1 You can set the timer to the length of time you want the fireplace to operate (1 to 120 minutes).
- 2 Press the "TIMER" button once. The Timer display "----" will blink.
- 3 Press the Up and Down buttons to set the timer. The LCD will display the time chosen.
- 4 The timer setting can be cancelled at any time by press and hold the "TIMER" button.
- 5 Press Manual or Auto On/Off button to turn on the fireplace.
- 6 The fireplace will turn off at the end of the timer setting.

Figure 6

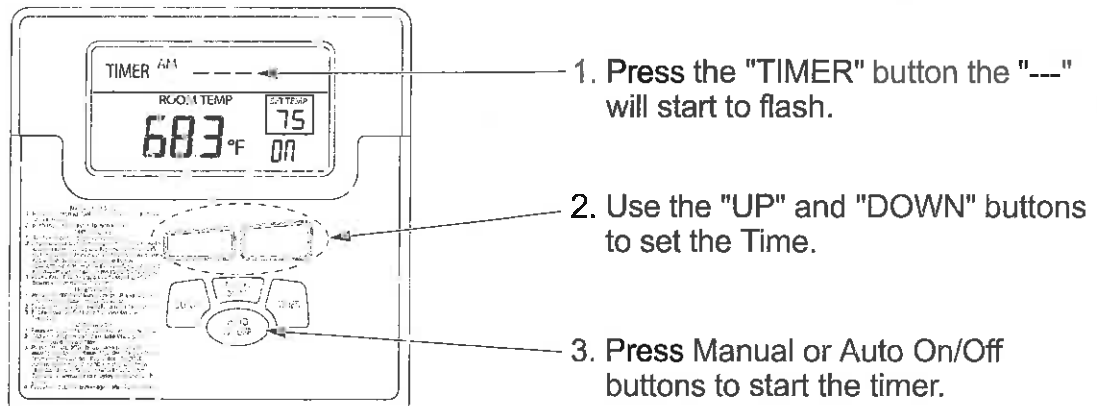

**E. Child-Proof Function : see Figure 7**

- 1 There is a CHILD-PROOF switch at the back of the Remote Transmitter.
- 2 Slide the CHILD-PROOF switch to position marked C/P to activate the CHILD-PROOF function and the child-proof function icon will appear on the LCD.
- 3 In CHILD-PROOF the Remote Transmitter will not operate the Remote Receiver until the "child-proof" code is used or the switch is returned to the other position.
- 4 Press the Up and Down buttons in the following sequence, Up-Down-Down-Up-Down, within 2 seconds, button function will be temporarily restored, the child-proof function icon will disappear from the LCD.
- 5 If no button is pressed within 2 minutes, the Remote Transmitter will return to the Child-Proof function and the child-proof function icon will reappear on the LCD until the Child-Proof switch is slide back to the other position.

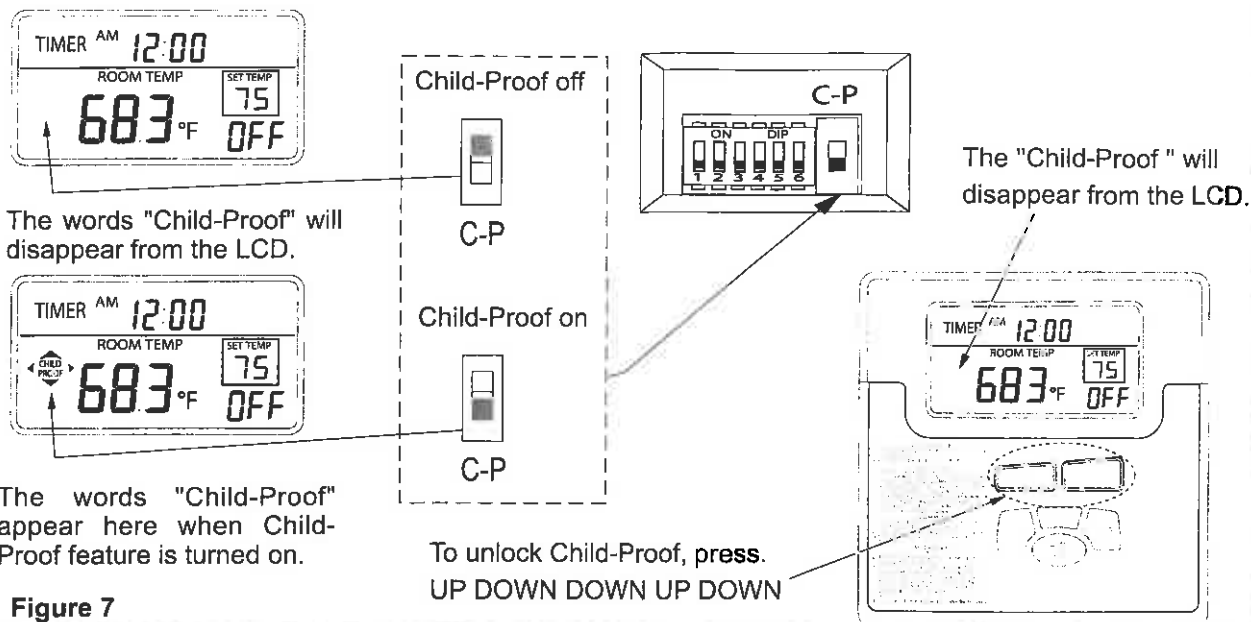
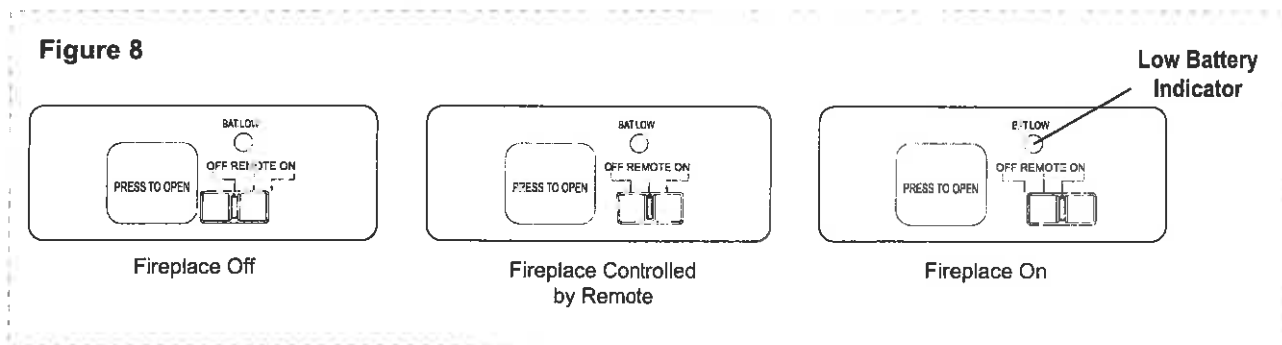

Figure 7

## 2.2 RECEIVER OPERATION: see figure 8

The Remote Receiver has 3 operation modes. They are ON, OFF and Remote modes .

- A. "ON" Mode  
The Receiver will turn on the fireplace and not responding to the wall mount Transmitter .
- B. "Remote" Mode  
The Receiver will respond to the Wall Mount Transmitter and turn the fireplace on and off accordingly.
- C. "OFF" Mode  
The Receiver will Close the fireplace and not responding to the wall mount Transmitter .



## ATTENTION: IMPORTANT SAFETY FEATURE see figure 9 6HR Safety Timer(FACTORY DEFAULT IS "ON")

### Enable - Timer Set to "ON"

In case of Transmitter failure (Malfunction / Battery run out) or out of transmission range, The Receiver will shut down the fireplace automatically after 6Hr of no Transmitter signal detection.

### Disable - Timer Set to "OFF"

The Receiver & Fireplace will continue operate in the last setting and will not shut off automatically even in case of Transmitter failure. (Note: Not recommended)

Figure 9

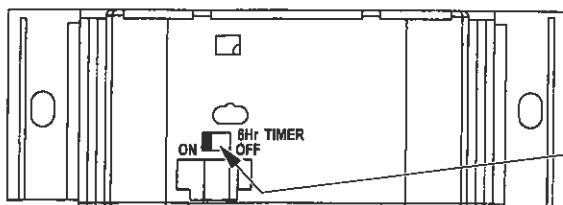

	First 2Hr since last signal received	Following 4Hr	6 <sup>th</sup> Hr since last signal received
Receiver/Fireplace Status	ON	Intermittent and Check For Transmitter Signal	Shut down if no signal received
NOTE: AUTO MODE ONLY			

### 3.0 IMPORTANT SAFETY FEATURE: See Figure 10.

You can set a private code into your system to prevent accidental operation by another transmitter nearby.

Figure 10

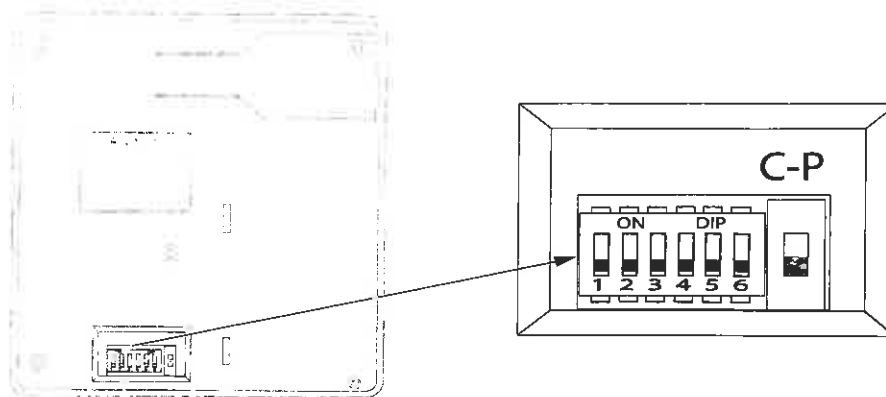

### 3.1 Coding Instructions: see figure 11

- 1 There are code switches at the back of the Remote Wall Mount. Slide the code switches to your choice of ON or OFF positions. FACTORY SETTING IS ALL 'OFF'.
- 2 Make sure the slide switch on the Remote Receiver is at the OFF position.
- 3 Take the Remote Wall Mount close to the fireplace or the Remote Receiver (less than 2-10 feet from the fireplace or Remote Receiver is recommended.)
- 4 Slide the slide switch on the Remote Receiver to REMOTE position.
- 5 Install fresh AAA alkaline batteries into the Remote Wall Mount.
- 6 Press any button on the Remote Wall Mount. The Remote Receiver will produce a 'beep' sound when it receives the code from the Remote Wall Mount. The system is now ready to operate.
- 7 If you do not hear a 'beep' sound from the Remote Receiver, remove batteries from the Remote Wall Mount and slide the slide switch on the remote receiver to OFF position, wait for 1 minute, and repeat step 3 to 6.
- 8 If you desire to operate multiple Remote Receivers with the one Remote Wall Mount, continue to hold the button on the Remote Wall Mount as you bring the Remote Wall Mount within 5 feet of each Remote Receiver then slide the slide switch on the Remote Receivers to the REMOTE position. Each will acknowledge receipt of coding with a beep.

Figure 11

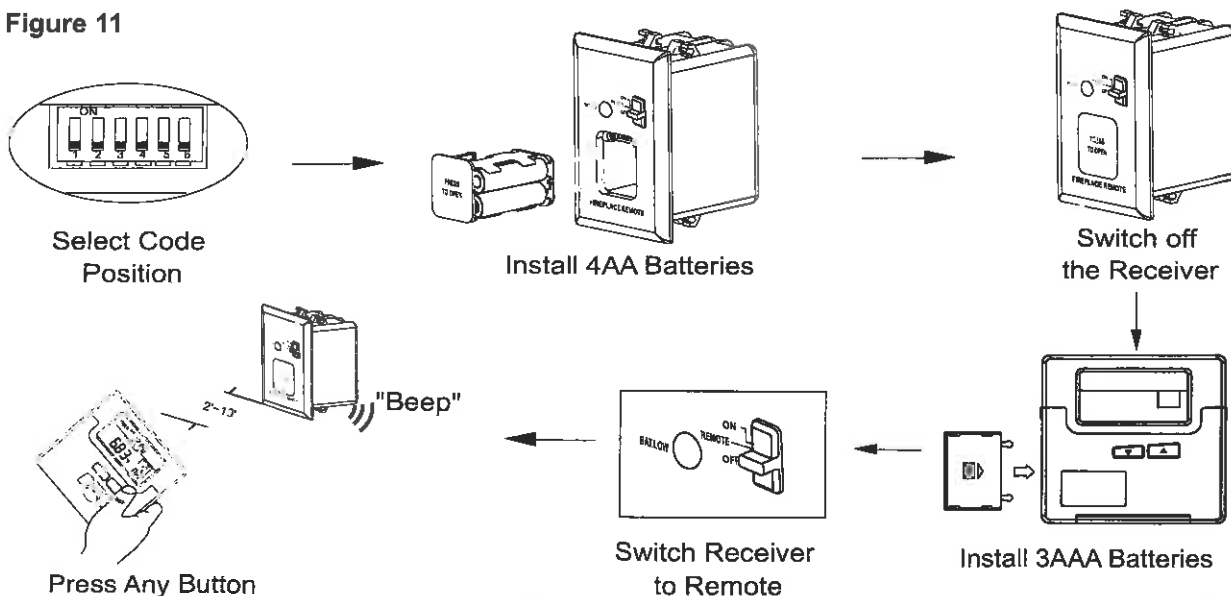

**Note: User must repeat SET PRIVATE CODE every time they change the code.**

## FCC Requirements

Warning: Changes or modifications to this unit not expressly approved by the party responsible for compliance could void the user authority to operate the equipment. This equipment has been tested and found to comply with the limits for a Class B digital device, pursuant to Part 15 to the FCC Rules. **These** limits are designed to provide reasonable protection against harmful interference in a residential installation. This equipment generates, uses, and can radiate radio frequency energy and, if not installed and used in accordance with the instructions, may cause harmful interference to radio communications. However, there is no guarantee that interference will not occur in a particular installation. If this equipment does cause harmful interference to radio or television reception, which can be determined by turning the equipment off and on, the user is encouraged to try to correct the interference by one or more of the following measures:

Reorient or relocate the receiver antenna.

Increase the separation between the equipment and receiver.

Connect the equipment into an outlet on a circuit different from that to which the receiver is connected

Consult the dealer or an experienced radio TV technician for help.

## Canadian Equipment Requirements

This digital apparatus does not exceed the (class A/Class B)\* limits for radio noise emissions from digital apparatus set out in the Radio Interference Regulations of the Canadian Department of Communications. Le present appareil numerique n'met pas de bruits radioelectriques depassant les limites applicables aux appareils numeriques (de la class A/de la class B)\* prescrites dans le Reglement sur le brouillage radioelectrique edicte par le ministere des Communications du Canada.

This device complies with RSS-210 of Industry and Science Canada. Operation is subject to the following two conditions : (1) this device may not cause interference, and (2) this device must accept any interference, including interference that may cause undesired operation of the device.

All wiring should be done by a qualified electrician and shall be in compliance with local codes and with the National Electric Code ANSI/NFPA No. 70-current (In the United States), or with the current CSA C22.1 Canadian Electric Code (in Canada).



# WMT- 04 Wall Mount Fireplace Remote Control Installation Instructions

## (PLACE LEAVETHE INSTRUCTIONS TO THE HOMEOWNER)

The Acumen WMT-04 Wall Mount Remote Control is designed for use with decorative gas fireplace and wall heaters using millivolt gas valve.

The WMT-04 Wall Mount Transmitter is a six-button hand held transmitter, which turn the gas on/off or as a thermostat. The display of the transmitter shows the clock, current room temperature, target temperature, timer setting, on/off status, low battery indicator and "child-proof".

### Installation Precautions:

The WMT-04 Wall Mount Remote Control is tested **safe** when installed in accordance with this installation manual. It is your responsibility to read all instruction before starting installation and to follow these instructions carefully during installation.

The WMT-04 Wall Mount Remote Control **MUST** be installed by a qualified service technician.

The WMT-04 Wall Mount Remote Control is carefully engineered and **MUST** be installed only as specified. If you modify it or any of its components, you may possibly cause a fire hazard.

### FCC Requirements

Warning: Changes or modifications to this unit not expressly approved by the party responsible for compliance could void the user authority to operate the equipment. This equipment has been tested and found to comply with the limits for a Class B digital device, pursuant to Part 15 to the FCC Rules. These limits are designed to provide reasonable protection against harmful interference in a residential installation. This equipment generates, uses, and can radiate radio frequency energy and, if not installed and used in accordance with the instructions, may cause harmful interference to radio communications. However, there is no guarantee that interference will not occur in a particular installation. If this equipment does cause harmful interference to radio or television reception, which can be determined by turning the equipment off and on, the user is encouraged to try to correct the interference by one or more of the following measures:

- Reorient or relocate the receiver antenna.
- Increase the separation between the equipment and receiver.
- Connect the equipment into an outlet on a circuit different from that to which the receiver is connected.
- Consult the dealer or an experienced radio TV technician for help.

### Canadian Equipment Requirements

This digital apparatus does not exceed the (class A/Class B)\* limits for radio noise emissions from digital apparatus set out in the Radio Interference Regulations of the Canadian Department of Communications. Le présent appareil numérique n'met pas de bruits radioelectriques dépassant les limites applicables aux appareils numériques (de la class A/de la class B)\* prescrites dans le Reglement sur le brouillage radioelectrique edicte par le ministere des Communications du Canada.

This device complies with RSS-210 of Industry and Science Canada. Operation is subject to the following two conditions : (1) this device may not cause interference, and (2) this device must accept any interference, including interference that may cause undesired operation of the device.

All wiring should be done by a qualified electrician and shall be in compliance with local codes and with the National Electirc Code ANSI/NFPA No. 70-current (In the United States), or with the current CSA C22.1 Canadian Electirc Code (in Canada).

# 1.0 Installation Instruction

## 1.1 Installing the Receiver

- 1 Make sure the slide switch on the Remote Receiver is at the OFF position.

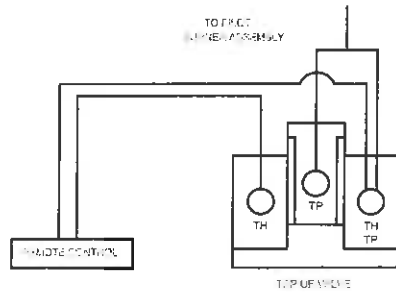

Figure 1

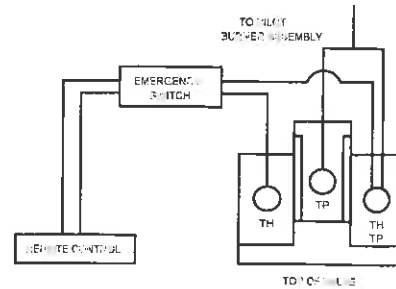

Figure 2

- 2 Connect the leads to the millivolt generator and the main burner to the output cable of the Remote Receiver as shown in Figure 1 (or Figure 2 if the optional Emergency Switch is used).
- 3 Installing the Remote Receiver to a Wall Mount:
  - Secure the Remote Receiver to the wall mount. See figure 3.
  - Use the screws provided to secure the face plate to the Remote Receiver.

### Installation of the Receiver to a Junction Box

Installation of the Receiver to a Junction Box:

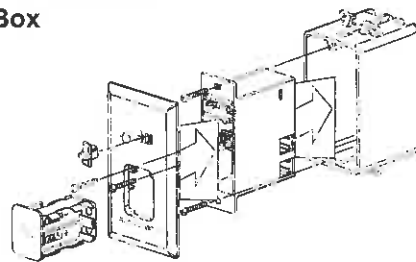

Figure 3

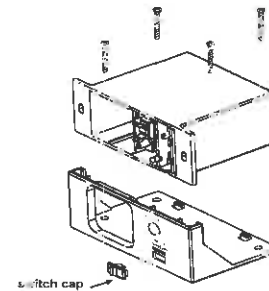

Figure 4

- 4 Installing the Remote Receiver to a Fireplace:
  - Secure the Fireplace Mounting plate to the base pan of the fireplace.
  - Slide the Remote Receiver into the fireplace mounting plate. See Figure 4.

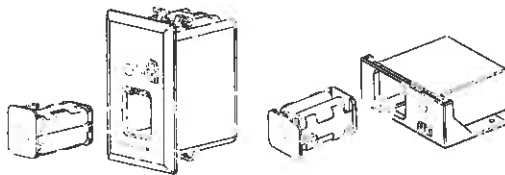

Figure 5

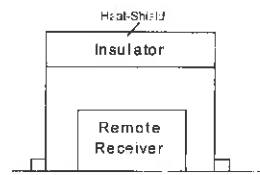

Figure 6

- 5 Put the switch cap to the slide switch.
- 6 Slide the battery compartment into the Remote Receiver. See Figure 5.
- 7 In order to prevent the Remote Receiver (fireplace installation only) from overheating, put a heat shield (option item) above the Remote Receiver. See Figure 6.

## 1.2 Installing the Remote wall mount Transmitter

- 1 Install the Wall Mount bracket horizontally onto the wall using the screws provided. See figure 7.
- 2 Slide the Wall Mount Transmitter onto the Wall Mount bracket as shown is figure 8.



figure 7

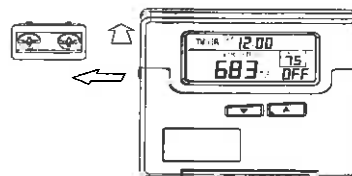

figure 8